

FIXTURE TYPE _____

PROJECT NAME _____

LOCATION _____



CH-217-N

EXTRUDED ALUMINUM MOUNTING CHANNEL



I Features

- Available in 2 Meter Sections
- Extruded Aluminum Construction
- Anodized Matte Finish
- Consult Factory for Custom Lengths & Finishes







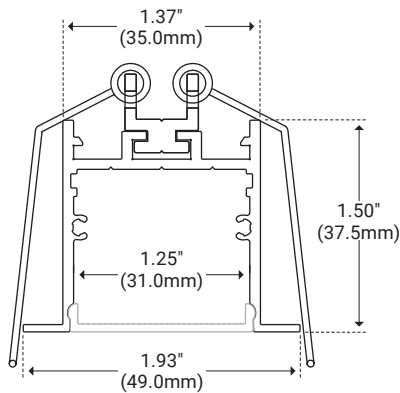



I Specifications

Series	CH-217-N
Length	78.74" (2M)
Width	1.93" (49.0mm)
Internal Width	1.25" (31.0mm)
Height	1.50" (37.5mm)

I Dimensions



I Options

Description	Unit Number
 White Lens	WH
 Frosted Lens	FR
 Clear Lens	CL
 Spring Clips	SG
 90° Connector	--
 90° Connector	--
 120° Connector	--
 180° Connector	--
 End Cap With Hole	EC
 End Cap Without Hole	EC

I Product Code Builder

Series	Length	Lens	Mounting	End Cap
CH-217-N	2		SG	EC
CH-217-N – CH-217-N	2 – 2 Meters	WH – White FR – Frosted CL – Clear	SG – Spring Clip	EC – End Caps (included) Example: CH-217-N-2-WH-SG-EC