

FIXTURE TYPE _____

PROJECT NAME _____

LOCATION _____

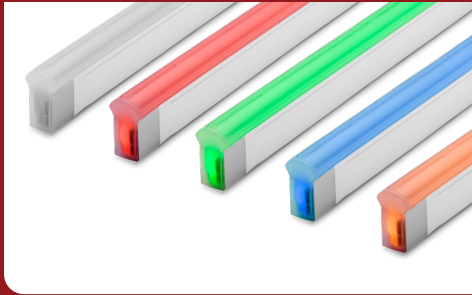

Signwave® 5 Silicone

WIDE VIEW FLEXIBLE LIGHTING SYSTEM



I Description

High brightness, a wide viewing angle, and multiple configurations make Signwave 5 our best seller. Offered in static colors, RGBW, and Color Tuning, this series tackles projects with fluid, seamless connections.

I Features

- Dimmable
- 50,000 Hour Life
- Domed Profile for Large Beam Angle
- IP68
- UL-Listed for Indoor and Outdoor Use
- Factory-Installed Power Feed
- Injection-Molded Flush End Caps
- For Use with 24V Power Supplies

I Specifications

Series	SW5S
Temp/Color	Static White, Red, Green, Blue, Amber, RGBW, CT (2200K–5700K)
Input Voltage	24V DC
Lumens per Foot	162 lm/ft (Static White)
Watts per Foot	2.2–4.6 [†]
Beam Angle	320°
CRI	80+
Max Run Length	Unlimited [†]
Dimensions	0.62" (16.0mm) × 0.68" (17.0mm)
Dimming Options	PWM, Triac, 0–10V, DMX, Hi-lume
Operating Temp	-40°F (-40°C) to 131°F (55°C)

I Dimensions

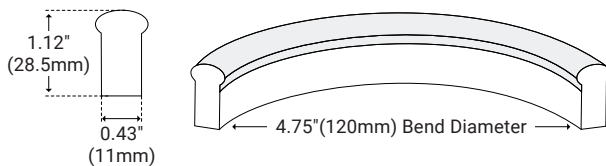

[†] See Series Data for more information



Product Code Builder

Series	Length	Temp/Color
SW5S		
SW5S — Signwave 5 Silicone	xx.xx — Length (in)	27K — 2700K 30K — 3000K 35K — 3500K 40K — 4000K 57K — 5700K RD — Red GRN — Green BL — Blue AM — Amber RGBW — Color Changing CT — Color Tuning
Feed Point	Feed Length	Rating
		IP68
B — Bottom Feed SL — Side-Feed Left SR — Side-Feed Right E — End Feed	S — Standard (118") xx.xx — Length (in)	IP68 — IP68 Rated

Example: SW5S-36-27K-B-S-IP68

Series Data

	Static White (Specify CCT)	Red	Green	Blue	Amber	RGBW	CT (22K–57K)
Wavelength (nm)	N/A	620–630	520–530	465–475	585–595	N/A	N/A
Wattage (W/ft)	3.7	2.2	3.7	3.7	2.2	4.6	3.7
Power Feed (ft)	Every 26ft	Every 40ft	Every 26ft	Every 26ft	Every 40ft	Every 21ft	Every 26ft
Production Intervals (in)	3.25"	4.93"	3.25"	3.25"	4.93"	3.93"	3.25"

Ferrule

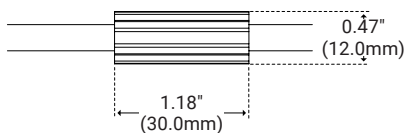

DryWire ferrule located 4.53" (± 0.39 ") from the cable connector. Protects against damage from water ingress inside cable wire. Please note that any attempt to remove the anti-wicking ferrule will result in the voiding of the warranty.

Feed Locations

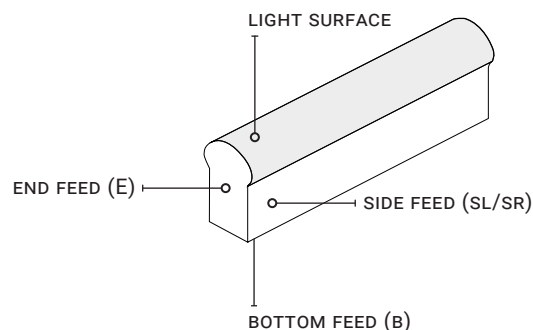



| Feed Options

Bottom Feed (IP68)‡

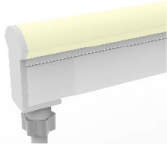

Unit Number	B
Unit Width	φ0.39" (φ10mm)

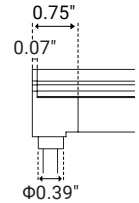
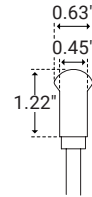

Side Feed Right/Left (IP68)‡

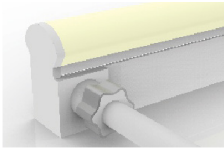

Unit Number	SL/SR
Unit Width	φ0.39" (φ10mm)

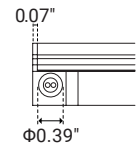
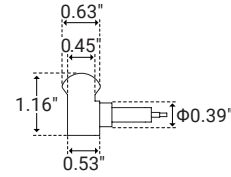

End Feed (IP68)‡

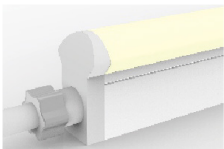

Unit Number	E
Unit Width	0.63" (16mm)
Unit Height	0.66" (16.7mm)

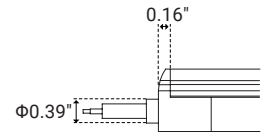
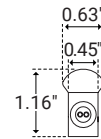

| End Cap

End Cap (IP68)

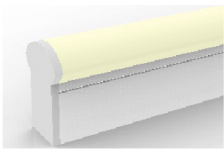

Unit Number	EC
Unit Width	0.62" (15.7mm)
Unit Height	0.66" (16.7mm)

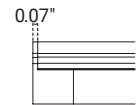
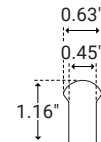

‡ Ferrule not included. The provided drawings and images are intended solely as a visual reference and does not fully depict the final product.



I Accessories

Aluminum Serrated Channel



Unit Number	SW-E-AL-CH-SR-2M
Material	Aluminum
Length	78.75" (2m)
Width	0.63" (15.9mm)
Height	0.98" (24.8mm)
Internal Width	0.46" (11.8mm)

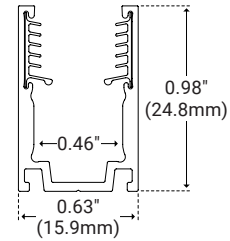

Aluminum Serrated Clip



Unit Number	SW-E-CLP-AL-SR
Material	Aluminum
Length	0.79" (20.0mm)
Width	0.63" (15.9mm)
Height	0.98" (24.8mm)
Internal Width	0.46" (11.8mm)

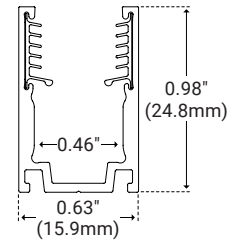

Serrated Recessed Channel



Unit Number	SW-E-AL-CH-SR-RC-2M
Material	Aluminum
Length	78.75" (2m)
Width	1.00" (25.5mm)
Height	0.98" (24.8mm)
Internal Width	0.46" (15.9mm)

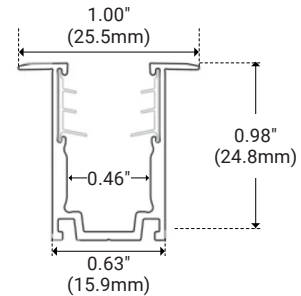

Aluminum Serrated Flex Channel



Unit Number	SW-E-CH-AL-FLX-1M
Material	Aluminum
Length	39.30" (1m)
Width	0.63" (15.9mm)
Height	0.98" (24.8mm)
Internal Width	0.46" (11.8mm)

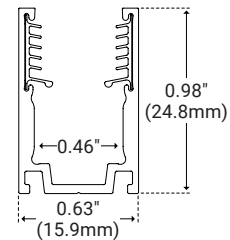

Side Mounting Bracket



Unit Number	SW-CLP-RA
Material	Aluminum
Length	0.78" (20.0mm)
Width	0.98" (25.0mm)
Height	2.75" (70.0mm)

Must be paired with channel

